

HPH

Heat recovery units

HIGH EFFICIENCY WITH BUILT-IN
HEAT PUMP SYSTEM

from 700 to 22.500 m³/h

Supporting structure in extruded aluminium profiles and curtain panels (42mm. thick) of sandwich type with special sealing gaskets; exterior finish RAL 9002; thermal acoustic mineral wool insulation class 0 and high density.

Filtering sections of F7 efficiency class with soft bags on the outside air circuit and M5 on exhaust air circuit, removable from the side.

Fan sections with single inlet backward-curved blades plug-fans directly coupled to EC Brushless electronic motors.

Static recovery system of the air-to-air flows cross-flow type, with high efficiency, Eurovent certified, equipped with aluminium heat exchanger plates, complete with bypass damper for free cooling and on/off actuator. Second section of dynamic heat recovery obtained with cooling reversible R410A system, essentially consisting of:

hermetic compressor/s, twin rotary brush less EC complete with dedicated inverter, evaporator/condenser with finned tubes in Cu/Al, electronic expansion valve, reverse cycle valve, high pressure gauge, high and low pressure transducers, separators and fluid receivers.

Complete control panel with display on board machine and microprocessor for temperature control at inlet flow fixed point, based on the operation logics designed to maximize energy savings and environmental comfort, thanks to the modulation of cooling power and air flow guaranteed by the inverter technology. The unit is designed for RS485 connection to supervision systems based on Modbus RTU protocol.

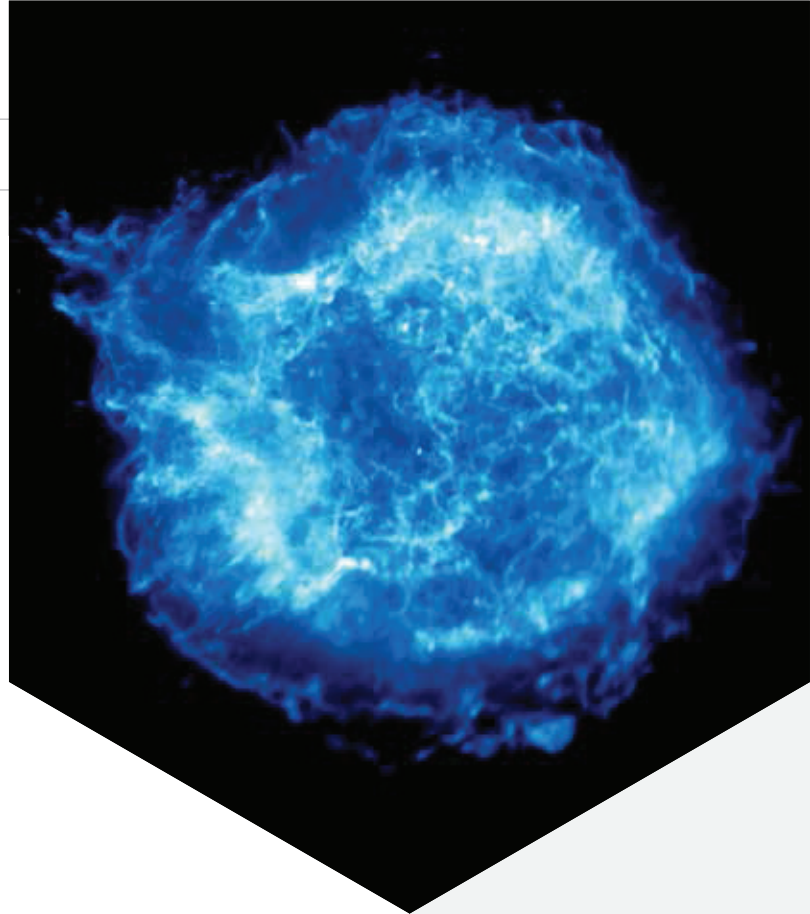

HP



ROTARY



EC FANS



EC COMP



R410A



PLUG&PLAY

Accessories

Pre and/or post-heating electrical coil	SKE
External water cooling/heating section	CCS
3-way valve with actuator	V33
3 damper mixing chamber	MS3
Additional compact filter class M6 (on fresh air)	FC6
Soft bag filter class F7 (on return air)	FT7
Soft bag filter class F8 (on fresh air)	FT8*
Filters differential pressure gauge	PSTD
Differential pressure transducer	DPS
CO2 air quality sensor	AQS
Room hygrostat	HAS
Ductable hygrostat	HCS
External damper	SKR
On/off actuator with spring return for external damper	SSE
External hood with network	CFA
Flexible connection	GAT
Roof for outdoor installation	TPR

(*) to be combined with FC6



ELECTRONIC EXPANSION VALVE



MODULATING FANS AND HIGH EFFICIENCY FILTERS



PRESSURE SENSORS FOR CONTROLLING THE FLOW OR PRESSURE



EFFICIENCY



ERP 2015



INSIDE



FULL OUTSIDE

Models

HPH		14	20	26	50	92	144	205
Airflow	m ³ /h	1200	2100	2900	5700	9500	13500	19000
Rated static prevalence	Pa	250	250	250	250	250	250	250
Maximum static pressure	Pa	491	493	550	476	687	548	670
1 m sound pressure level at the outside of the machine	dB(A)	43	47	43	47	51	50	53
Total max current absorption	A	16,5	30,8	40,6	32,3	50,1	69,9	100,3
Power supply	V-Ph-Hz	230-1-50			400-3-50			
Efficiency (1)	%	59,2	58,0	57,3	60,2	59,0	61,8	60,3
Recovered cooling capacity (1)	kW	1,30	2,30	3,10	6,50	10,6	15,8	21,7
Compressor cooling capacity (1)	kW	6,47	11,30	15,6	30,7	51,2	72,7	102,0
Total cooling capacity (1)	kW	7,77	13,6	18,7	37,2	61,8	88,5	124
Available cooling capacity (1)	kW	2,45	4,28	5,92	11,6	19,4	27,5	38,8
EER (1)		3,08	3,06	3,01	3,07	3,01	3,04	3,06
Supply temperature (1)	°C	20,0	20,0	20,0	20,0	20,0	20,0	20,0
Efficiency (2)	%	73,9	72,4	71,5	75,1	73,6	74,0	72,9
Recovered heating capacity (2)	kW	9,4	16,0	21,9	45,2	73,8	106	146
Compressor heating capacity (2)	kW	6,98	12,60	17,60	32,6	55,6	78,5	112,0
Total heating capacity (2)	kW	16,4	28,6	39,5	77,8	129	184	259
Available heating capacity (2)	kW	2,45	4,28	5,92	11,60	19,4	27,5	38,8
COP (2)		3,49	3,40	3,38	3,43	3,31	3,34	3,41
Supply temperature (2)	°C	28,0	28,0	28,0	28,0	28,0	28,0	28,0
FANS								
Max current consumption	A	2 x 2,17	2 x 5,83	2 x 5,91	2 x 3,80	2 x 7,98	4 x 5,13	4 x 7,98
Max. total power absorbed	kW	2 x 0,50	2 x 1,35	2 x 1,35	2 x 2,50	2 x 5,20	4 x 3,30	4 x 5,20
2009/125/EC ErP Compliance	-	2015	2015	2015	2015	2015	2015	2015
Motor protection rating		IP54	IP54	IP54	IP54	IP54	IP54	IP54
Power supply	V-Ph-Hz	230-1-50			400-3-50			
COMPRESSOR								
Refrigerant gas		R410A						
Type		rotary	rotary	rotary	rotary	rotary	rotary/scroll	rotary/scroll
Quantity		1	1	1	1	1	2	2
Max current consumption	A	12,2	19,2	28,8	24,7	34,2	2 x 24,7	2 x 34,2
Full load power input	kW	2,38	3,74	5,63	13,0	18,0	2 x 13,0	2 x 18,0
Power supply	V-Ph-Hz	230-1-50			400-3-50			
ELECTRIC SKE HEATING ACCESSORY (1)								
Stages		1	1	1	1	1	1	1
Heating capacity	kW	6,00	10,0	14,0	28,0	48,0	64,0	80,0
Current consumption	A	8,66	14,4	20,2	40,4	69,3	92,4	115
ΔT air side	°C	14,7	14,0	14,2	14,4	14,9	13,9	12
Pressure drop	Pa	25	25	25	25	25	25	25
Power supply	V-Ph-Hz	400-3-50						
ELECTRIC SKE HEATING ACCESSORY (2)								
Stages		1	1	1	1	1	1	1
Heating capacity	kW	3,00	5,00	7,00	14,0	24,0	32,0	40,0
Current consumption	A	4,33	7,22	10,1	20,2	34,6	46,2	57,7
ΔT air side	°C	7,4	7,0	7,1	7,2	7,4	7,0	6,2
Pressure drop	Pa	17	17	17	17	17	17	17
Power supply	V-Ph-Hz	400-3-50						

(1) Outdoor air 32°C 50% RH, ambient air 26°C 50% RH

(2) Outdoor air -10°C 90% RH, ambient air 22°C 50% RH

Performance

PERFORMANCE

HPH 14

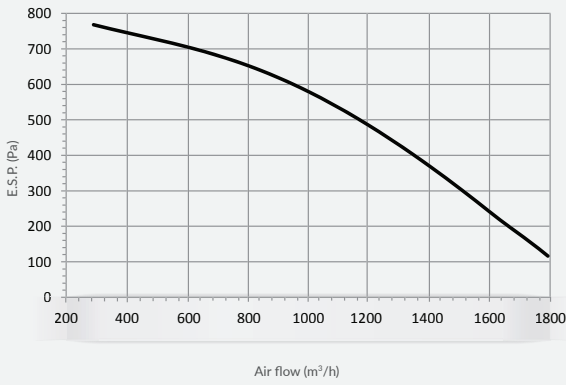

HPH 20

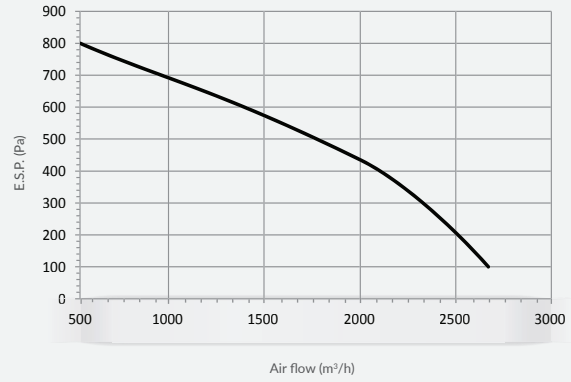

HPH 26

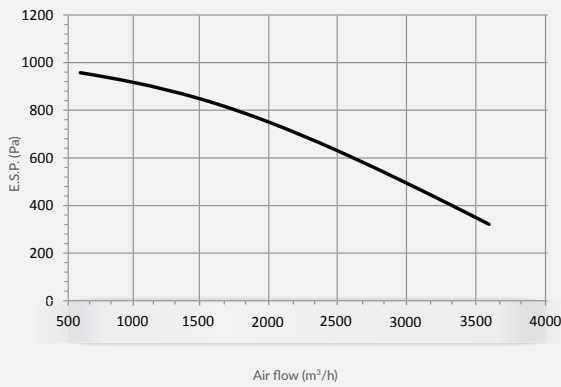

HPH 50

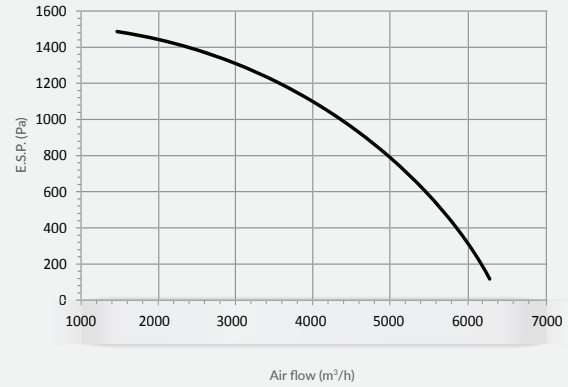

HPH 92

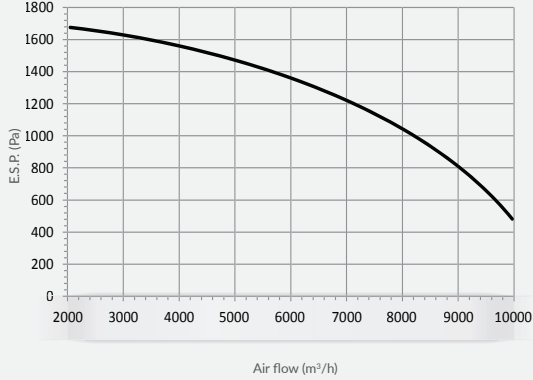

HPH 144

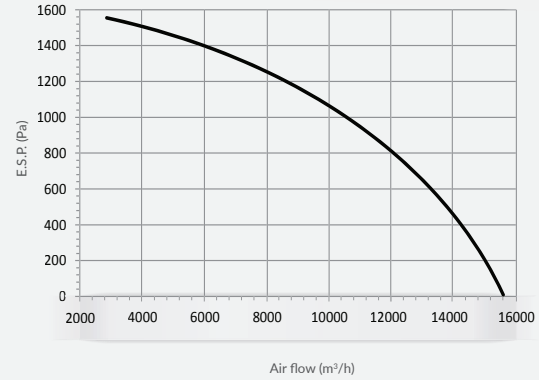

HPH 205

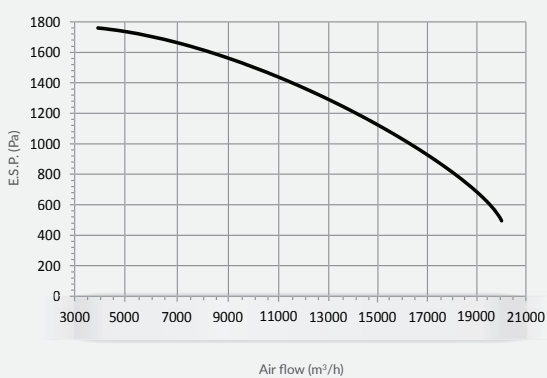

Noise levels

The table lists the sound power values (SWL) in octave bands and totals; it also indicates the values of sound pressure level (SPL) at 1 m, 5 m and 10 m at supply, return and at the outside of the unit.

All values refer to the operation of the ducted unit at FULL speed and at the nominal flow rate.

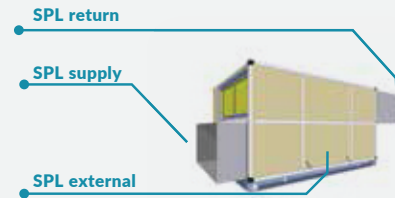

HPH	SWL [dB] OCTAVE BAND [HZ]								SWL		SPL SUPPLY			SPL RETURN			SPL OUTSIDE		
	63	125	250	500	1000	2000	4000	8000	dB	dB(A)	1 m	5 m	10 m	1 m	5 m	10 m	1 m	5 m	10 m
14	43,0	50,0	70,0	66,0	66,0	69,0	66,0	59,0	75	74	61	49	43	55	45	39	43	33	27
20	55,0	60,0	74,0	74,0	71,0	73,0	70,0	64,0	80	78	67	53	47	59	49	43	48	38	32
26	50,0	56,0	71,0	70,0	67,0	69,0	66,0	60,0	76	74	63	49	43	54	45	39	43	34	28
50	46,0	54,0	75,0	76,0	74,0	74,0	71,0	70,0	82	80	69	55	49	58	49	44	47	38	33
92	50,0	58,0	80,0	78,0	80,0	78,0	75,0	83,0	87	86	75	61	55	64	55	50	52	43	38
144	47,0	56,0	81,0	76,0	78,0	78,0	75,0	75,0	86	84	73	59	53	61	53	48	50	42	37
205	53,0	61,0	84,0	81,0	83,0	81,0	78,0	86,0	91	89	78	64	58	65	57	53	53	45	41

Dimensions and weights

HPH		14	20	26	50	92	144	205
a	mm	2185	2185	2515	2845	3175	3505	3835
B	mm	1030	1195	1360	1690	2020	2350	2350
C	mm	1190	1190	1190	1520	1850	2180	2510
L	mm	620	785	950	1280	1610	1940	1940
H	mm	475	475	475	640	805	970	1135
Weight	kg	550	650	800	1000	1200	1550	1850

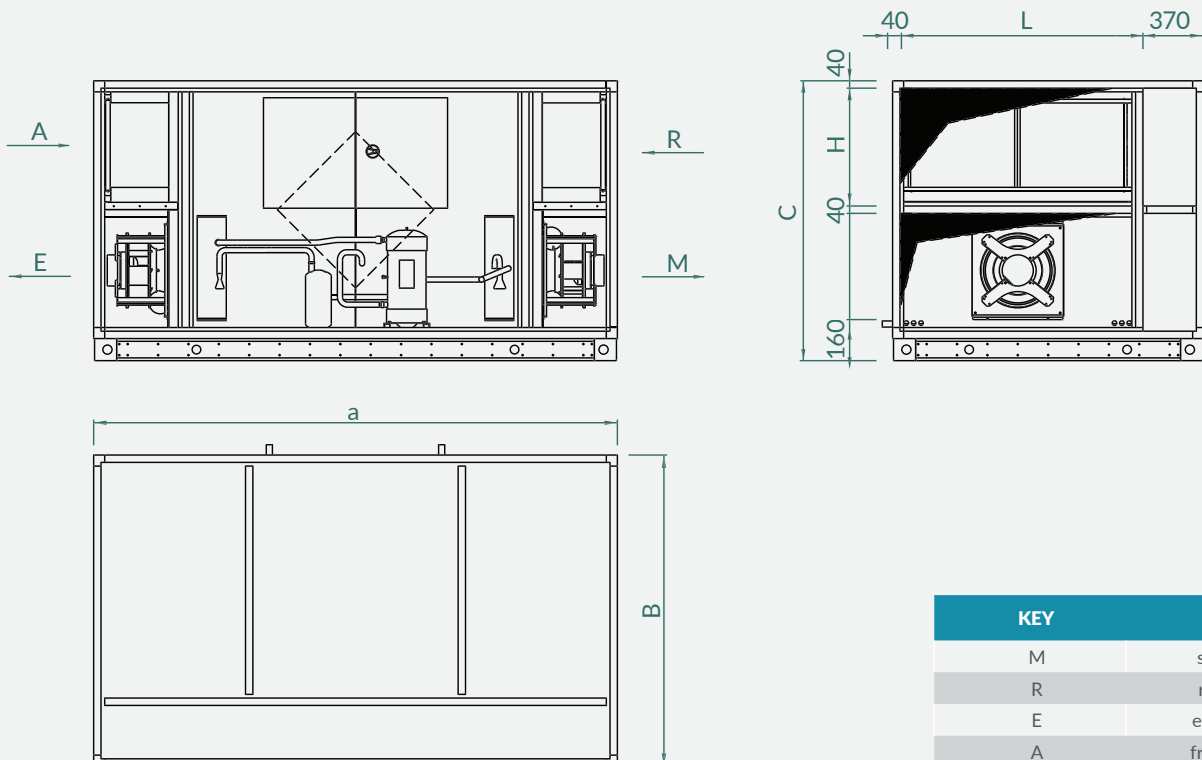

KEY

M	supply
R	return
E	exhaust
A	fresh air

HPH		14	20	26	50	92	144	205
L1	mm	150	150	150	150	150	150	150
L2	mm	100	100	100	100	100	100	100
L3	mm	635	635	635	800	965	965	965
L4	mm	535	535	535	535	535	535	535
W1	mm	470	635	800	1130	1460	1790	1790
H1	mm	395	395	395	560	725	890	1055

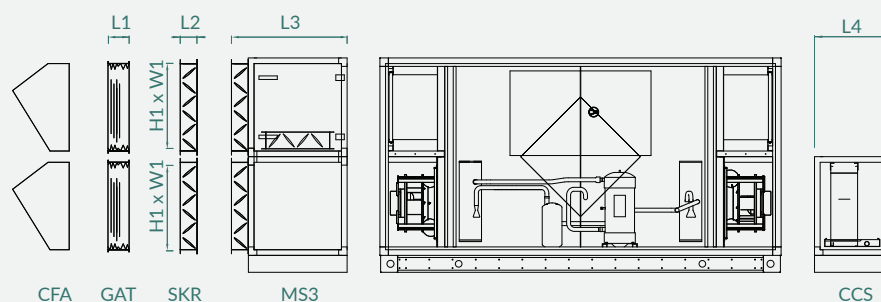

Controls

Automatic selection of speed		•
EC fans management		•
Management of the cooling circuit with inverter compressor		•
Management of the electronic expansion valve		•
Reading pressure and temperature of the cooling circuit		•
Management of cooling unit defrost		•
Management of summer dehumidification		•
Manual ON-OFF		•
Cool/change over valve management	CCS+V33	•
Defrost recovery management		•
Water coil anti-freeze management		•
ON-OFF electric heater management	SKE	•
Filter pressure switch management	PSTD	•
Management of ventilation with CO2 probe	AQS	•
Management of ventilation with one or two pressure sensors	DPS	•
Management of free cooling modulating damper		•
Management of free-heating modulating damper		•
Management of mixing chamber	MS3	•
Management of motorized dampers	SKR+SSE	•
Alarms management		•
Post ventilation		•
Weekly programming		•
Remote ON-OFF		•
Mode change (hot/cold) from digital input		•
Display on board machine		•
Remote display	RCT	•
Fixed point adjustment at flow		•
Adjustment of temperature and ambient humidity	HAV HCV	•
BMS Modbus RS485 protocol		•
Reference diagram		24